



HUME DOORS & TIMBER



PRODUCT CATALOGUE

100% Australian Owned

www.humedoors.com.au



WELCOME



“When it comes to designing a home the natural flow and seamless integration of the inside and out is important. Doors play a pivotal role in this design element. Practical consideration to door design helps provide timeless aesthetics for your home.”

- Janet Coker, Specifying Dynamics



HUME VALUES

- To innovate and make a difference in your home
- To continue to build valued relationships with staff, suppliers and distributors
- To continue to improve on our environmental sustainability and recycling

HUME DOORS & TIMBER
HISTORY
Find out where it started »



Hume Doors & Timber is the nation's largest 100% Australian owned timber door manufacturer with over 60 years of proud history. Hume Doors will always stand by its family based values and exceptional customer service. Whether leading the way in sustainability, innovation or design, Hume Doors & Timber remains committed to developing outstanding products for the Australian market.



CONTENTS

ENTRANCE

5 - 21

ILLUSION.....	5	JOINERY.....	12	DURADOOR.....	16
SAVOY1200.....	6	VAUCLUSE PREMIER.....	13	NEXUS.....	17
SAVOY820.....	7	REGENCY.....	14	CAMDEN.....	17
VERVE.....	8	TREND.....	14	CARRINGBUSH.....	18
LINEAR.....	9	BRUNSWICK.....	15	LINCOLN.....	18
VAUCLUSE.....	10	VENETIAN.....	15	BFR DOORS (BUSHFIRE RANGE).....	19
NEWINGTON.....	11	SANDGATE.....	16	GLASS OPENING.....	20

ENTRANCE SYSTEMS

PIVOT FRAMES, ALFRESCO MULTIFOLD, WEATHERGUARD 21

INTERNAL

22 - 33

HUMECRAFT.....	22	CHIC.....	26	MOULDED PANEL WOODGRAIN.....	28
SORRENTO.....	23	STRATA.....	26	MOULDED PANEL SMOOTH SKIN.....	29
JOINERY.....	24	PREMIUM.....	27	ACCENT.....	30
LINEAR.....	25				

FLUSH

SOLICORE, SOLIDCORE, HONEYCOMB CORE 31

INTERNAL SYSTEMS

PRE-HUNG.....	31	MULTI-FOLD.....	31
FLUSH BI-FOLD.....	31	SMARTROBE.....	32
BI-FOLD.....	31	CAVITY UNITS.....	33

GLAZING OPTIONS

34 - 35

COMMERCIAL

36

COMMERCIAL PRODUCTS, FIRE DOORS, STEEL DOOR FRAMES 36

TIMBER

37

EXTRAS

20, 38 - 40

DOOR MASS AND REBATED HANDING.....	20	OVERHEAD PROTECTION.....	39
STEEL DOOR FRAME WARRANTY.....	38	CARE AND MAINTENANCE.....	39
GUARANTEE DOORS.....	38	CONTACT DETAILS.....	40



HOW TO HANG A DOOR

Want to hang your door? We make it easy.
 Watch our HumeHowTo video for instructions:
www.humedoors.com.au/hume-how-to-change-a-door.php

NEW DOOR INSTALLATION



Scan QR code to view our installation video





ENVIRONMENTAL STATEMENT

Hume Doors & Timber is committed to operating its entire business processes in an environmentally sustainable manner at all times. We embrace environmental awareness, protection and enhancement. Our goal is to be regarded as an environmentally responsible corporate citizen that practices environmental stewardship and provides our valued customer base with complete confidence that our products have been produced in accordance with applicable independent environmental standards.

- Hume Solar Power Scheme - Reducing our carbon footprint
- Reusing and recycling by-products, packaging and waste material
- Reducing the level of packaging and consumables used
- Capturing, storing and using rainwater for our water needs
- Maximise transport loads, thus reducing energy requirements



FSC® & PEFC™ CERTIFICATION

Hume Doors & Timber (Aust) Pty Ltd is a certified member of the Forest Stewardship Council® (SGS-CoC-009377) as well as a member of the Programme for the Endorsement of Forest Certification Schemes (SGS-PEFC/CoC-1532).



The mark of responsible forestry



Hume Doors & Timber (Qld) Pty Ltd is also a certified member of the Forest Stewardship Council (SGS-CoC-009405).



The mark of responsible forestry



BAL COMPLIANCE



Hume Doors & Timber has extensively tested its comprehensive range of doors and door frame systems, which include both hinged and pivoted entry frame systems up to 2700 x 1200, to meet the AS1530.8.1 criteria set for buildings in BAL (Bushfire Attack Level) zoned areas without compromising on functionality and aesthetics.

Look out for our BAL symbol throughout our Catalogue for compliance. Doors must be installed as per AS3959-2009 to conform to BAL (Bushfire Attack Level) compliance. Refer to our website for further information: www.humedoors.com.au



SOUND RATING



Hume Doors & Timber has extensively sound tested its comprehensive range of doors. Sound Transmission Class (STC) tested to ASTM E 413-87 and Acoustic Weighted Reduction (Rw) tested to ISO 717-1.

Look out for our sound rating symbol throughout our Catalogue. To achieve the rating doors must be installed with seals of equivalent RW/STC and must be installed as per the seal manufacturers recommendations. Refer to our website for further information; www.humedoors.com.au



ILLUSION



FACE OPTIONS



SPM

GLASS OPTIONS



Clear



Grey Tint



Frost



Africana

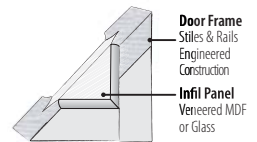

Door Frame
Stiles & Rails
Engineered
Construction

Infil Panel
Veneered MDF
or Glass

**BOLD, INDIVIDUAL
& DREAMY**

The Illusion range has inserts that appear to float, these doors make for a stunning impression, all the while allowing for an abundance of light to enter into your home. Choose from clear, frost, grey or Africana glass to complete the illusion.

Standard Door Size:
2040x820x40, 2040x1200x40

Standard Sidelite Size:
2040x400x40

Check with your Hume state office
for made to order



XIL21



XIL22



XIL23



XIL26



XIL1



XIL2



XIL3



XIL6



JST11



BAL 12.5 Only available for Glazed
Clear Laminated, Grey Laminated
and Translucent.
Check pricing with your state
Hume office



SAVOY 1200

FACE OPTIONS



GLASS OPTIONS

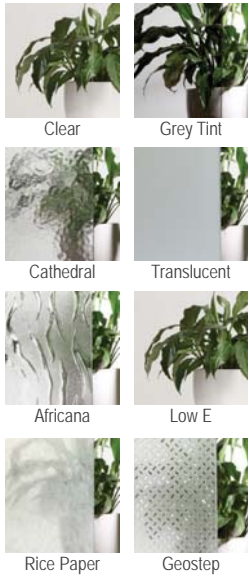

**GRAND, KING-SIZED
& STUNNING**

The Savoy 1200 range is engineered using joinery construction techniques featuring veneered laminated timber stiles and rails. Crafted from select timbers and available with a range of glass options to suit your style.

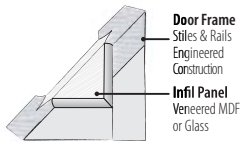

Standard Door Size:
2040x1200x40,
2340x1200x40
Check with your Hume state office
for made to order

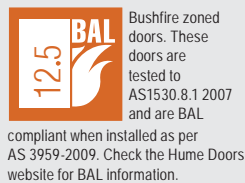

XS26



XS24



XS45



XS28



SAVOY 820



FACE OPTIONS

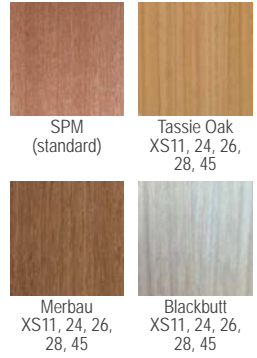

SPM (standard)

Tassie Oak XS11, 24, 26, 28, 45



Merbau XS11, 24, 26, 28, 45

Blackbutt XS11, 24, 26, 28, 45

GLASS OPTIONS



Clear

Grey Tint

Cathedral

Translucent

Low E

Africana

Geostep

Rice Paper

Note: For other glass designs refer to Glazing Options table on page 34-35

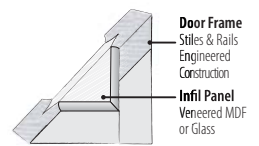

Door Frame Stiles & Rails Engineered Construction
Infill Panel Veneered MDF or Glass

Standard Door Size: 2040x820x40

Standard Sidelite Size: 2040x400x40

Check with your Hume state office for made to order



Bushfire zoned doors. These doors are tested to AS1530.8.1 2007 and are BAL

compliant when installed as per AS 3959-2009. Check the Hume Doors website for BAL information.

STUNNINGLY EYE CATCHING

The Savoy 820 range is engineered using joinery construction techniques featuring veneered laminated timber stiles and rails. Crafted from select timbers and available with a range of glass options to suit your style.



XS2



XS2 With mouldings and raised panels



XS3



XS4



XS11



XS24



XS26



XS28



XS45



FACE OPTIONS

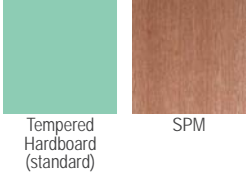

GLASS OPTIONS

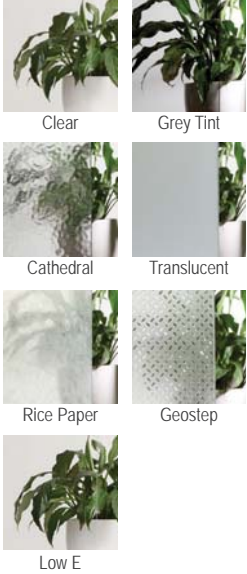

**SOPHISTICATED,
CRISP & NEAT**

The Verve range has been designed with sleek slim glass panels, making for the finest in contemporary design. An extensive range of glass options create endless possibilities in style.

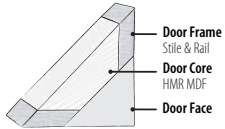

Standard Door Size:
2040x820x40
Check with your Hume state office
for made to order

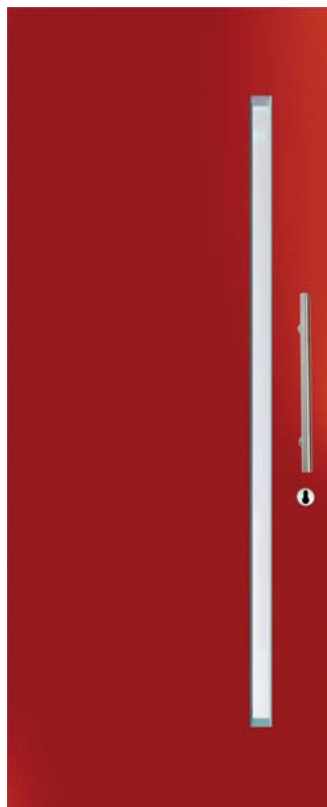
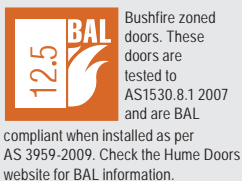

VER1



VER2



VER4



VER6



VER8



VER11



LINEAR



FACE OPTIONS



GLASS OPTIONS

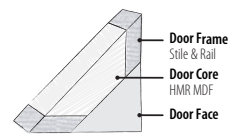
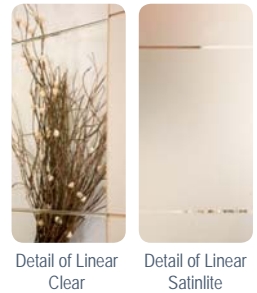

Standard Door Size: 2040x820x40

Alignment of horizontal rout is not guaranteed for pairs. Not suitable for rebated pairs. Check with your Hume state office for made to order



12.5 BAL Bushfire zoned doors. These doors are tested to AS1530.8.1 2007 and are BAL compliant when installed as per AS 3959-2009. Check the Hume Doors website for BAL information.

STRIKING, UNIQUE & STYLISH

Our designers have been inspired by modern European trends which has shaped the Linear range of doors. This unique range can showcase the natural beauty of timber with the innovation of contrasting grains or can be painted for that fresh stylish feel.



XLR110

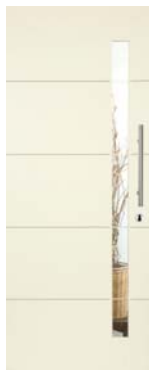

XLR120



XLR130



XLR140



XLR150



XLR160



XLR170



XLR180



XLR300



XLR310



XLR320



VAUCLUSE

FACE OPTIONS



GLASS OPTIONS

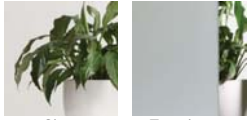

CRAFTSMANSHIP & SIMPLICITY

The Vaucluse is of the highest quality and our designers have produced a variety of styles to match any architectural frontage. Detailed carved patterns to the external faces and smooth internal faces make for simplicity in design.

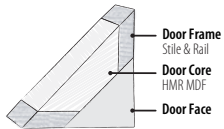

Standard Door Size:
2040x820x40

Sidelite option refer Newington (XN9 & XN14) page 11

Check with your Hume state office for made to order



Bushfire zoned doors. These doors are tested to AS1530.8.1 2007 and are BAL

compliant when installed as per AS 3959-2009. Check the Hume Doors website for BAL information.



XV1



XV4



XV5



XV6



XV9



XV10



XV14



XV18



XV20



NEWINGTON



**POPULAR, ATTRACTIVE
& VERSATILE**

The Newington range has a popularity that is a testament to its everlasting appeal and unmatched adaptability. The choice of dazzling designs, an array of glass options and matching sidelites provides limitless choices for you to create the look.

FACE OPTIONS



GLASS OPTIONS

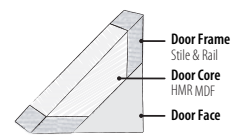

Standard Door Size:
2040x820x40

Standard Sidelite Size:
2040x200x40 (XN14),
2040x400x40 (XN9)

Check with your Hume state office for made to order



Bushfire zoned doors. These doors are tested to AS1530.8.1 2007 and are BAL compliant when installed as per AS 3959-2009. Check the Hume Doors website for BAL information.

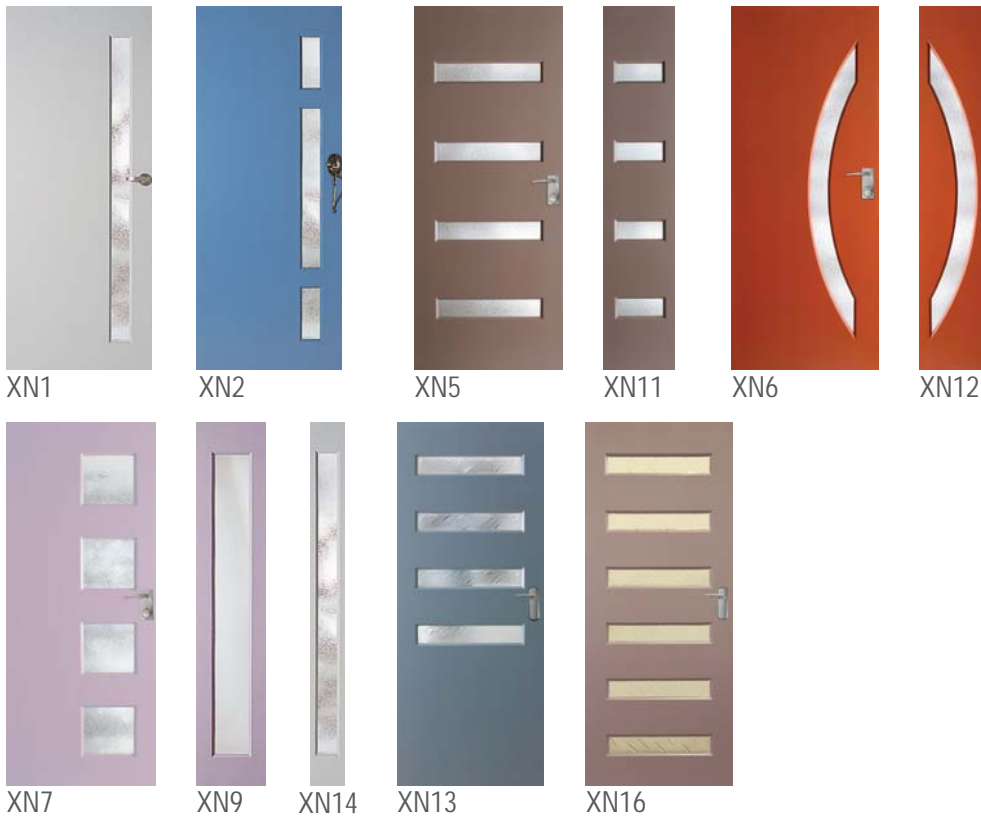



JOINERY

FACE OPTIONS



SPM
(standard)



Tassie Oak
(JST1/JST2)



Merbau
(JST1/JST2)



Blackbutt
(JST1/JST2)

GLASS OPTIONS



Clear



Clear Laminated



Grey Tint



Cathedral

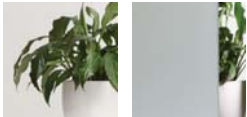

Double Glaze
Clear



Translucent



Double Glaze
Frost



Africana



Low E



Rice Paper



Geostep

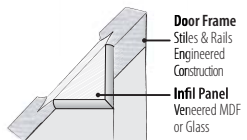

Door Frame
Stiles & Rails
Engineered
Construction
Infill Panel
Veneered MDF
or Glass

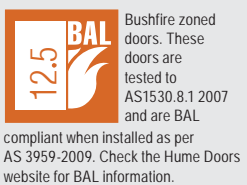

CLASS & CHARM

The Joinery range is the ideal match to traditional architecture. Crafted from select timbers and available with a range of glass options to suit your style. This range features an engineered joinery construction system, which utilises traditional joinery methods as well as incorporating modern techniques. Note: JST1 doors with clear glass includes a safety decal strip centre of glass panel.



JST2



JST1



JST11



JST4



JST12



JST6



JST10



JST5

Standard Door Size:
2040x720x40, 2040x820x40
Standard Sidelite Size:
2040x400x40

Check with your Hume state office
for made to order



VAUCLUSE PREMIER

ENTRANCE



FACE OPTIONS

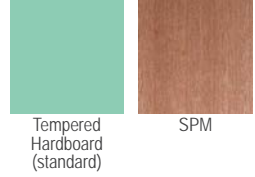

GLASS OPTIONS

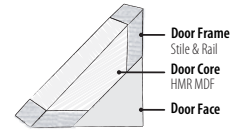
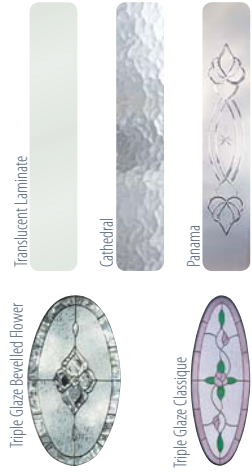

SOUND RATING	Unglazed	Glazed
Rw	30	31
STC	29	31

12.5 BAL Bushfire zoned doors. These doors are tested to AS1530.8.1 2007 and are BAL compliant when installed as per AS 3959-2009. Check the Hume Doors website for BAL information.

PREMIUM & SUPERIOR BY DESIGN

Vaucluse Premier doors have deep carved patterns on both sides of the door together with attractive moulding to the external side. A wide range of glass options are also available to match any decor.



XVP5



XVP6



XVP11



XVP12



Optional Raised Panel to suit: XVP11/12/13



XVP13



XVP14



XVP20

Standard Door Size: 2040x820x40
 Standard Sidelite Size: 2040x400x40
 Check with your Hume state office for made to order



REGENCY

FACE OPTIONS

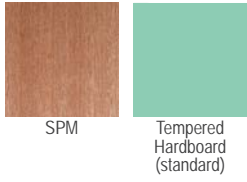

GLASS OPTIONS

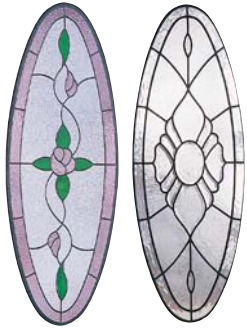

Triple Glaze Classicque Triple Glaze Bevel Flower

Note: For other glass designs refer to Glazing Options table on page 34-35

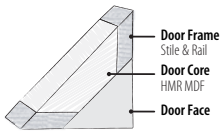

XR1 XR2 XR6



XR5 XR4



SUPREME & CLASSIC

The Regency range offers timeless designs with substantial timber mouldings to the exterior face plus deep routed designs to both door faces. Solid construction with a number of glazing options available, including triple glaze leadlight designs to complement any classically styled home.



Bushfire zoned doors. These doors are tested to AS1530.8.1 2007 and are BAL compliant when installed as per AS 3959-2009. Check the Hume Doors website for BAL information.

SOUND RATING	
Rw 30	
STC 29	
Unglazed	

SOUND RATING	
Rw 31	
STC 31	
Glazed	

Standard Door Size: 2040x820x40
Standard Sidelite Size: 2040x400x40
Check with your Hume state office for made to order



TREND

FACE OPTIONS

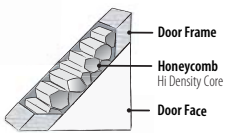
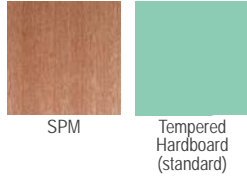

SOUND RATING	
Rw 25	
STC 25	

Standard Door Size: 2040x820x40
Check with your Hume state office for made to order



XT5 XT6



XT7 XT8



SAVVY & IN VOGUE

Trend doors have unique carved patterns on both sides of the door together with dense premium door faces. Non solid construction.



BRUNSWICK



XB1



XB2



XB5



XB6



XB7



XB8



XB11



XB12



XB13



Smooth Skin
XB8, XB12,
XB13



Woodgrain Skin
XB1, XB2, XB5,
XB6, XB7, XB11

FACE OPTIONS



Primed MDF

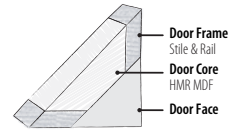

Standard Door Size:
2040x820x40,

Check with your Hume state office
for made to order

Check your state for availability



PRECAST & PLEASANTLY DESIGNED

The Brunswick is a range of pre-primed moulded panel solid entrance doors for application in moisture protected situations only. Woodgrain or smooth skin depending on the model. Design both sides.



VENETIAN

SHUTTER SLIDERS



Venetian features magnetic finger sliders for easy operation:
(A) Tilt adjustments slider
(B) Raise and lower operations.



VEN1

VEN3

FACE OPTIONS



SPM

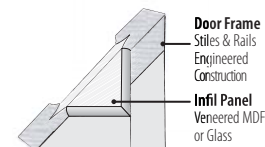

Standard Door Size:
2040x820x40



Bushfire zoned doors. These doors are tested to AS1530.8.1 2007 and are BAL compliant when installed as per AS 3959-2009. Check the Hume Doors website for BAL information.

CONTROL THE LOOK & PRIVACY OF A ROOM

The Venetian is a fully functional integrated blind system that lets you make the choice between light and dark without any of the cleaning and maintenance hassles of conventional blinds. Fully functional blinds tilt, raise and lower via magnetically driven finger tip controls. The Venetian is encompassed between two pieces of tempered safety glass removing the need for cleaning.



SANDGATE

FACE OPTIONS



SPM

Tempered Hardboard (standard)

GLASS OPTIONS



Frosted Kookaburra Green Leaves



Frosted Rose Bud



THRIFTY & TRADITIONAL

The Sandgate range has dense premium door faces and unique carved patterns on both sides with attractive moulding to the external face. A wide range of glass options are also available to match any decor.

Note: For other glass designs refer to Glazing Options table on page 34-35



Standard Door Size: 2040x820x40

Standard Sidelite Size: 2040x400x40

Check with your Hume state office for made to order



SG6



SG8



SG9



SG10

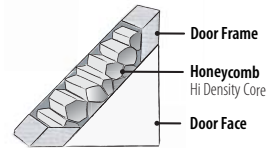

DURADOOR

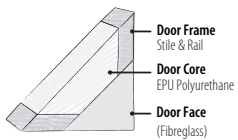

Standard Door Size: 2040x820x40



XD1



DURABLE & DEPENDABLE

Well suited to exposed situations the Hume Duradoor is a door designed to withstand harsh environments. Fibreglass faces are durable and will not split, crack or warp.



NEXUS



SUBTLE & STYLISH

The Nexus range is designed with urban architecture in mind. These smart designs are the perfect link between the city scape and your home. The array of glass options provides limitless choices for you to create the urban look.

FACE OPTIONS

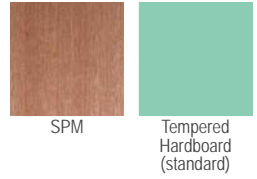

GLASS OPTIONS



NEX30



NEX35



NEX40

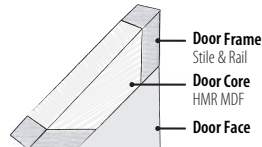

SOUND RATING
Rw 31
STC 31

12.5 BAL Bushfire zoned doors. These doors are tested to AS1530.8.1 2007 and are BAL compliant when installed as per AS 3959-2009. Check the Hume Doors website for BAL information.

Standard Door Size: 2040x820x40, 2040x1200x40 (NEX40)
Check with your Hume state office for made to order



CAMDEN



XC1



XC2

Standard Door Size: 2040x820x40

AFFORDABLE & HIGH QUALITY

This high quality yet affordable range of doors is designed with the investor in mind and ideal for those on a budget. They feature detailed timber mouldings to the external face. Camden doors are nonsolid.



FACE OPTIONS

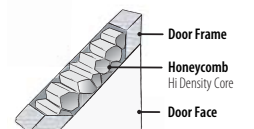
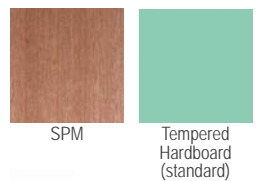

SOUND RATING
Rw 25
STC 25



CARRINGBUSH

FACE OPTIONS



SPM

Tempered
Hardboard
(standard)

GLASS OPTIONS

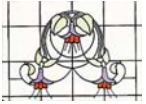

Wysteria Frost



Triple Glaze Argyle Leadlight



Triple Glaze Crystal Blue



XCB1



XCB2



XCB5

Standard Door Size:
2040x820x40Standard Sidelite Size:
2040x400x40Check with your Hume
state office for made
to order

CLASSICAL & TIMELESS

The Carringbush is a recreation of doors from the Victorian era. These doors incorporate routed designs each side and have the warmth of detailed timber mouldings, strong cricket bat panels, ledge and scroll on the exterior door face.

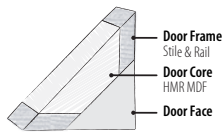
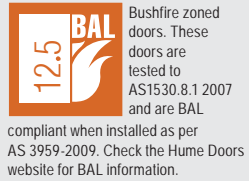

LINCOLN

FACE OPTIONS



SPM

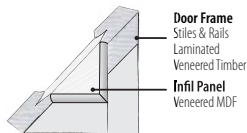

XL8

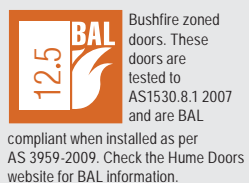

XL10

Standard Door Size:
2040x820x40

LUXURIOUS & EXCLUSIVE

The Lincoln range is the ideal match to traditional architecture or that executive fashioned residence. Crafted from select timbers this range features an engineered joinery construction system, which utilises traditional joinery methods as well as incorporating modern techniques.



BFR BUSH FIRE RESISTANT



BUSH FIRE RESISTANT

Hume offers an extensive range of doors designed and manufactured to meet the specific regulatory requirements of building in designated bushfire zones. We have a comprehensive range of doors that meet BAL12.5, BAL19 and BAL29 criteria as specified in AS3959. Select from either tempered hardboard or veneer finished solicore doors with 6mm tempered safety glass.



Bushfire zoned doors. These doors are tested and are BAL compliant when installed as per AS 3959-2009. Check the Hume Doors website for BAL information.

Doors suitable for bushfire zones BAL 12.5, 19, 29 when installed per AS 3959-2009- AMDT3-2011, solid construction with merbau glazing beads

FACE OPTIONS



GLASS OPTIONS

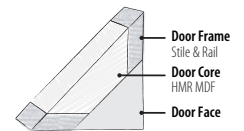

Standard Door Size: 2040x820x40

Check with your Hume state office for made to order





GLASS OPENING

FACE OPTIONS

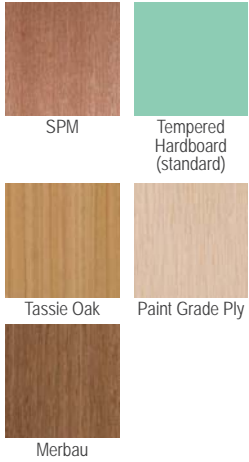

GLASS OPTIONS



SIMPLE & FUNCTIONAL

A classic back door design with three styles to choose from. Available in honeycomb core or the option of solid construction. Crafted from tempered hardboard or select timbers and offered with a range of glass options to suit your style.



Standard Door Size:
2040x820x35,
2040x820x40
Check with your Hume state office for made to order

12.5 BAL Bushfire zoned doors. These doors are tested to AS1530.8.1 2007 and are BAL compliant when installed as per AS 3959-2009. Check the Hume Doors website for BAL information.

FOR BAL COMPLIANCE: 40MM THICK AND SOLID CONSTRUCTION REQUIRED.

SOLICORE CONSTRUCTION

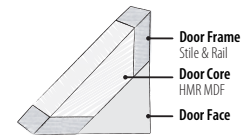

SOUND RATING
Rw 31
STC 31

HONEYCOMB CORE CONSTRUCTION

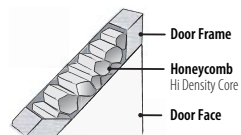

SOUND RATING
Rw 25
STC 25



DOOR MASS AND REBATED HANDING

STANDARD REBATE

Right hand door opens away first (Opens Clockwise)



REVERSE REBATE

Left hand door opens away first (Opens Anti-clockwise)



DESIGN CODE 2040X820X35/40/45	KILOGRAMS	DESIGN CODE 2040X1200X35/40/45	KILOGRAMS
Hollowcore Honeycomb	14	Hollowcore Honeycomb	18
Solicore Particleboard	40	Solicore Particleboard	58
Solidcore Timber Blockboard	35	Solidcore Timber Blockboard	56
Firedoor	40	Sorrento / Premium	30
Moulded Panel / Strata	15	Savoy 2340x1200x40	48
Sorrento / Premium	18	Newington / Vaucluse / Verve	58
Lincoln / Joinery / Savoy	30	Measurements are a guide ONLY, mass may vary	
Newington / Vaucluse / Verve	40		
Camden / Sandgate / Trend	15		



ENTRANCE SYSTEMS

PIVOT FRAMES

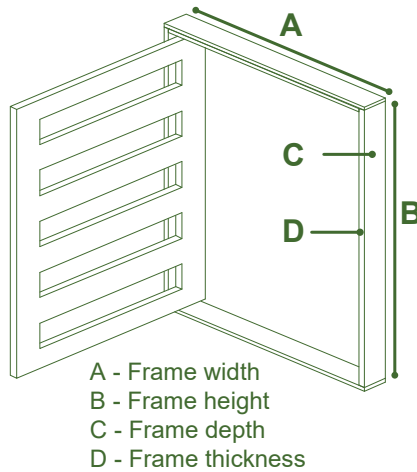

PIVOT FRAME OPTIONS

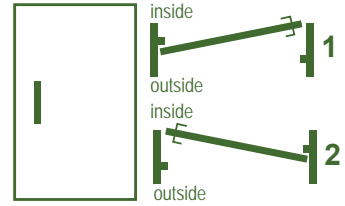

12.5 BAL Meranti pivot frames. These frames are tested to AS1530.8.1 2007 and are BAL compliant when installed as per AS 3959-2009. Check the Hume Doors website for BAL information.

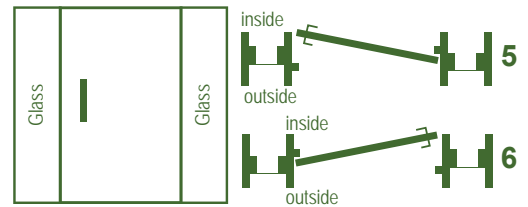
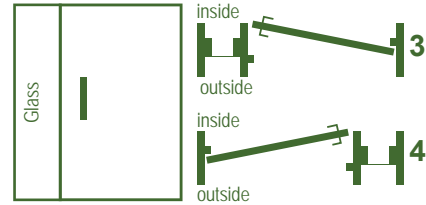

PIVOT DOOR INSTALLATION

HUME HOW TO

Scan QR code to view our installation video

Note: Door is additional. Allow for up to 1200 wide door. To choose your door see the entrance range.



WEATHERGUARD FRAMES



PREMIUM ENERGY EFFICIENT ENTRY FRAMES

- Material pine or meranti regular - check your state. Merbau as an optional extra
- Self-draining aluminium sill - improved moisture control
- Generous tread pattern on sill - reduces slip
- Frames have a full perimeter seal - improves energy efficiency and noise reduction
- Seal is removable for painting frame and is easily reinstalled
- Sill supplied with protective tape during construction - removable at handover
- Timber jambs and head
- Optional Wheelchair Sill - Additional \$95

SOUND RATING

Rw 31
STC 31



ALFRESCO MULTIFOLD



OUTDOOR LIVING

Double your living space by bringing the outside in! Compliment your home and enjoy the relaxing style of Al Fresco living featuring the Hume Al Fresco folding weather sealed door system.

ALFRESCO INSTALLATION

HUME HOW TO

Scan QR code to view our installation video



HUMECRAFT

FACE OPTIONS

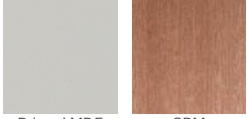

Primed MDF (standard)

SPM

GLASS OPTIONS

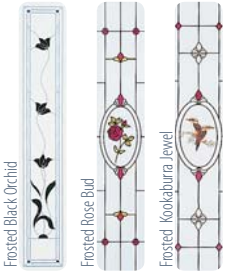

Frosted Black Orchid

Frosted Rose Bud

Frosted Kookaburra Jewel

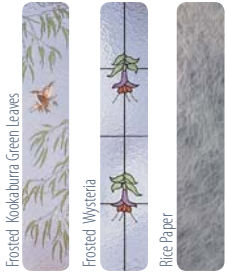

Frosted Kookaburra Green Leaves

Frosted Wysteria

Rice Paper

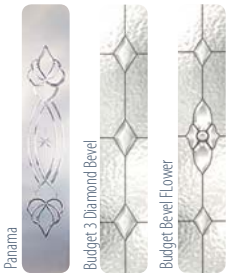

Panama

Budget 3 Diamond Bevel

Budget Bevel Flower

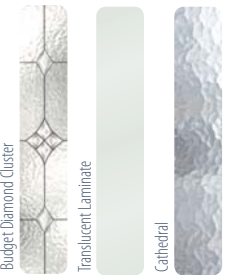

Budget Diamond Cluster

Translucent Laminate

Cathedral

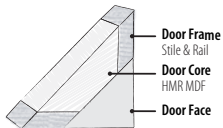

Door Frame
Stile & Rail
Door Core
HMR MDF
Door Face



DISCREET & TASTEFUL

The Humecraft is a range of high quality internal solid doors featuring broad square carved designs on both sides. Matching bi-folds add to their versatility. All models are solid construction and bi-folds are supplied with all the fittings required for installation.



HMC1



HMC2



HMC4



HMC5



HMC7



HMC8



HMC9



HMC10



HMC11



BF29



BF30

Standard Door Size:
2040x410/420/460/520/620/720/770/820x35

Standard Bi-Fold Size:
2040x720/770/820x35

Check with your Hume state office for made to order



SORRENTO



FACE OPTIONS



Primed MDF
(6mm thick)

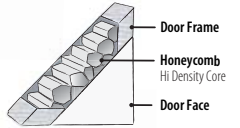

SOUND RATING 

Rw 27
STC 27

MODERN & LUXURIOUS

The Sorrento brings that fresh contemporary feel to your home. The Beautifully carved door designs feature on both sides and are produced on a deluxe primed door face.



SOR1



SOR2



SOR5



SOR6



SOR7



SOR11



SOR12

Standard Door Size:
2040x410/420/460/520/620/720/770/820x35
Check with your Hume state office for made to order



JOINERY

FACE OPTIONS



Merbau LIN1 SPM (standard)



Tassie Oak LIN1

GLASS OPTIONS

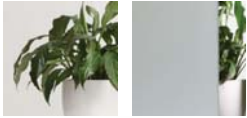

Clear Translucent



Rice Paper Cathedral



Grey Tint Geostep

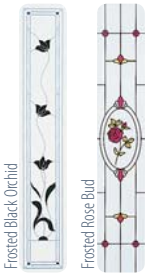

Frosted Black Orchid
Frosted Rose Bud

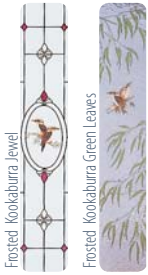

Frosted Kookaburra Jewel
Frosted Kookaburra Green Leaves

Note: For other glass designs refer to Glazing Options table on page 34-35



CLASS & CHARM

The Joinery range is the ideal match to traditional architecture. Crafted from select timbers and available with a range of glass options to suit your style. This range features an engineered joinery construction system, which utilises traditional joinery methods as well as incorporating modern techniques. Note: LIN1 doors with clear glass includes a safety decal strip centre of glass panel.



LIN1

LIN2

LIN3

LIN10

SAV2 (VIC only)

SAV3 (VIC only)

Standard Door Size:
2040x620/720/770/820x35 (LIN1, LIN2, LIN10, SAV2)
2040x820x35 (LIN3, SAV3)

Check with your Hume state office for made to order

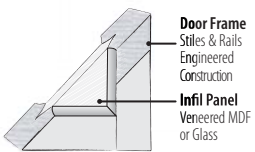

Door Frame
Stiles & Rails
Engineered
Construction
Infil Panel
Veneered MDF
or Glass



LINEAR



**STRIKING, UNIQUE
& STYLISH**

Our designers have been inspired by modern European trends which has shaped the Linear Range of doors. This unique range can showcase the natural beauty of timber with the innovation of contrasting grains or can be painted for that fresh stylish feel.

FACE OPTIONS



SPM
HLR250, 260,
280, 400, 410,
420 (standard)

Primed MDF
HLR210,
220, 230, 270
(standard)

GLASS OPTIONS

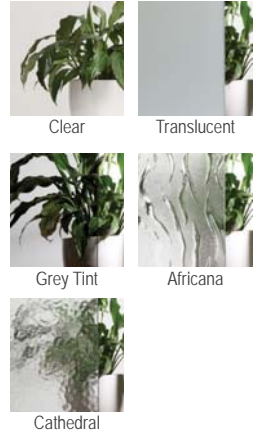

Clear

Translucent

Grey Tint

Africana

Cathedral

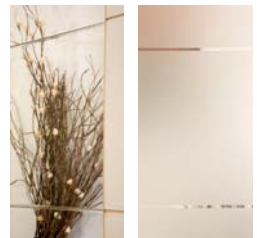

Detail of Linear Clear

Detail of Linear Satinlite

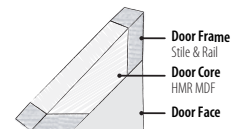

HLR 210, 220, 260, 280

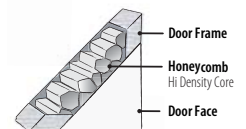

HLR 230, 240, 250, 270, 400, 410, 420



Alignment of horizontal rout is not guaranteed for pairs.
Not suitable for rebated pairs.



HLR210



HLR220

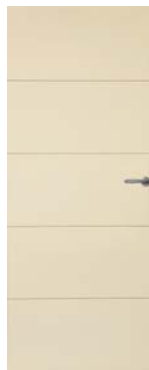

HLR230



HLR240



HLR250



HLR260



HLR270



HLR280



HLR400



HLR410



HLR420

Standard Door Size:
2040x520/620/720/770/820x35 (HLR220, 230, 240, 250, 260, 270, 400, 410, 420)
2040x820x35 (HLR210, 280)

Check with your Hume state office for made to order



CHIC

FACE OPTIONS

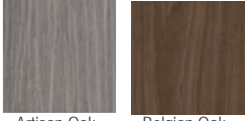

Artisan Oak Belgian Oak

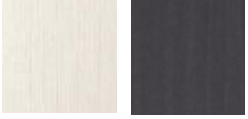

Gesso Lini Shannon Oak

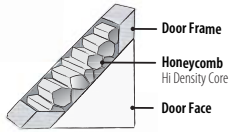

Standard Door Size:
2040x410/420/460/520/620/720/
770/820x35

Check with your Hume state office
for made to order



ARTISAN OAK



BELGIAN OAK



GESO LINI



SHANNON OAK



DARING & BOLD

The Chic range uses high pressure laminate door faces that removes the need for painting, staining or finishing. Modern, tough and durable with the beauty of a wood grain appearance. We have selected a range of four wonderful finishes that creates the chic look in your home.



STRATA

FACE OPTIONS



HST1 HST4



HST1M HST4M



HST5

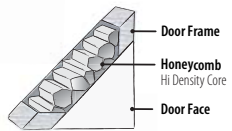

Standard Door Size:
2040x410/420/460/520/620/720/
770/820x35

Check with your Hume state office
for made to order



HST1



HST4



HST4M



HST5



HST1M



CLASSY, MODERN & INNOVATIVE

The Strata is unique and up to the minute in design, featuring eye-catching vertical and horizontal textured patterns. Complement your own personality with a splash of creativity, by adding a metallic strip. The Strata doors are primed ready for painting.



PREMIUM

INTERNAL



FACE OPTIONS



Primed MDF (6mm)

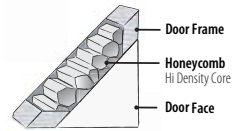

Standard Door Size:
2040x410/420/460/520/620/720/
770/820x35

Check with your Hume state office
for made to order

BRILLIANT & TRENDY

Painting is easy with the Premium range. This range has all the great modern styling tones and a thicker premium door skin. This enables the Premium to achieve an enhanced paint finish.



PRE1(SG15)

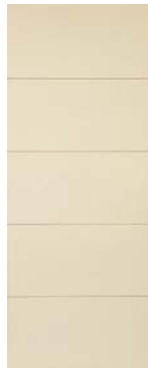

PRE4



PRE9



PRE11



PRE18



PRE40



PRE44



MOULDED PANEL

WOODGRAIN SKIN

Note: For other glass designs refer to Glazing Options table on page 34-35

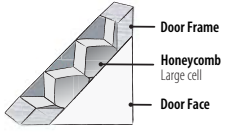

Standard Door Size:
2040x410/420/460/520/620/720/
770/820x35

2040x720/770/820x35 (OAK-G)

Standard Bi-Fold Size:
2040x720/770/820x35

Check with your Hume state office for made to order



CLASSICAL & TIMELESS

These Beautiful doors feature woodgrain embossed pre-primed faces to both sides and with so many different styles to choose from the Moulded Panel range has it all.

OAKFIELD



OAK



BF18



OAK-G



BF19

CAPRICE



CAP



BF34

PACIFIC



PAC



BF15

DENMARK



DEN



BF26

CHATEAU



CHA



BF33

VIENNA



VIE



BF25



Moulded Panel Woodgrain Skin



MOULDED PANEL

SMOOTH SKIN

INTERNAL



Note: For other glass designs refer to Glazing Options table on page 34-35

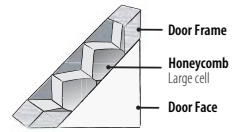

Standard Door Size:
 2040x410/420/460/520/620/720/
 770/820x35
 2040x520/620/720/770/820x35
 (ALP)
 2340x620/720/770/820x35 (ASC,
 ALP)
 2040x720/770/820x35 (ASC-G)
 Standard Bi-Fold Size:
 2040x720/770/820x35
 Check with your Hume state office
 for made to order



TRADITIONAL & REFRESHING

These Beautiful doors feature embossed smooth faces both sides in a range of refreshing designs plus the benefit of 2340 high doors with Ascot and Alpine models. With so many different styles to choose from the Moulded Panel range has it all.

ASCOT



ASC



BF27



ASC-G



BF28



ASC
2340MM HIGH

ALPINE



ALP



ALP
2340MM HIGH

HAYMAN



HAY



BF6



Moulded Panel
Smooth Skin



ACCENT

FACE OPTIONS



Primed MDF

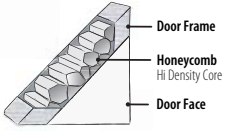

Standard Door Size:
2040x410/420/460/520/620/720/
770/820x35

Check with your Hume state office
for made to order



Rw 25
STC 25



ELEGANT & FASHIONABLE

The Accent internal door has trendy horizontal and vertical designs which create a modern straight forward style to suit any architectural theme.



HAG9



HAG11



HAG12



HAG14

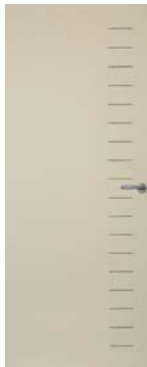

HAG18

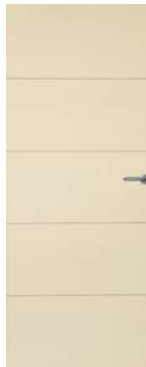

HA4



HA5



HA40



PRE-HUNG

INTERNAL



RIGHT HAND HINGED DOOR



LEFT HAND HINGED DOOR



89MM RADIUS CORNER HINGES



CHROME or SATIN CHROME BRASS STAINLESS STEEL

PRE-HUNG INSTALLATION



Scan QR code to view our installation video



- Factory fitted & ready to install
- Recommended by Australia's leading builders
- Saves time & money



SOLICORE, SOLIDCORE & FLUSH

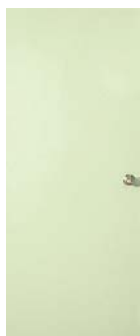

PC MDF



SPM



TEMPERED HARDBOARD



COMMERCIAL PC MDF
4.75mm or 6mm skins
honeycomb core

SOLICORE (SCX1)

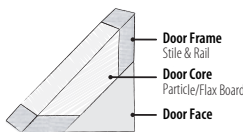

SOUND RATING	35mm
Rw	29
STC	29

SOUND RATING	40mm
Rw	30
STC	29

Timber frame with water resistant particle/flax board core. Variety of face materials.

SOLIDCORE (STPC)

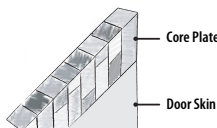

SOUND RATING	35mm
Rw	29
STC	29

SOUND RATING	40mm
Rw	30
STC	29

Pine block core. Variety of face materials.

FLUSH (HONEYCOMB CORE)

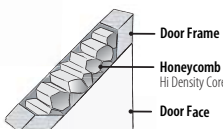

SOUND RATING	Primecoat
Rw	25
STC	25

SOUND RATING	Commercial Primecoat
Rw	27
STC	27

SOUND RATING	Light Commercial Primecoat
Rw	30
STC	29



BI-FOLD & MULTIFOLD OPTIONS



BF1 PC MDF (LEAF)



BF1 PC MDF (LEAF)



BF1 SPM (LEAF)



BF1 SPM (LEAF)



BI-FOLD DOOR INSTAL-

Scan QR code to view our installation video



MULTIFOLD OPTIONS

4 LEAF SET:
2.0M TRACK PLUS

A 1 Starter, 1 Add On Packs



6 LEAF SET:
2.5M TRACK PLUS

C 1 Starter, 2 Add On Packs



8 LEAF SET:
3.4M TRACK PLUS

E 1 Starter, 3 Add On Packs



B 2 Starter Packs



D 2 Starter, 1 Add On Packs



F 2 Starter, 2 Add On Packs



BI-FOLD OPTIONS

Standard Bi-fold



Two Standard Bi-fold



G 2 Starter, 2 Add On Packs





DOOR SIZE - UNIT HEIGHT (2040 = 2115, 2340 = 2415)				
DOOR WIDTH	WIDTH		WIDTH	
	INCLUDING 2 FINGER GRIPS PER DOOR		NO FINGER GRIPS	
	Unit Size	Stud Size	Unit Size	Stud Size
4x870	3670	3675	3460	3465
3x870	2770	2775	2610	2615
2x870	1870	1875	1760	1765
4x820	3470	3475	3260	3265
3x820	2620	2625	2460	2465
2x820	1770	1775	1660	1665
4x770	3270	3275	3060	3065
3x770	2470	2475	2310	2315
2x770	1670	1675	1560	1565
4x720	3070	3075	2860	2865
3x720	2320	2325	2160	2165
2x720	1570	1575	1460	1465
4x620	2670	2675	2460	2465
3x620	2020	2025	1860	1865
2x620	1370	1375	1260	1265
4x520	2270	2275	2060	2065
3x520	1720	1725	1560	1565
2x520	1170	1175	1060	1065



WHEEL ASSEMBLY
Also pictured is timber finger grip on door edge



TOP TRACK
Nylon guides supplied to fix top of doors to ensure smooth operation



BOTTOM TRACK
Easy maintenance with door height adjustment in edge of door



FLUSH RANGE
PAGE 31



ACCENT RANGE
PAGE 30



MOULDED
PAGES 28-29



LINEAR RANGE
PAGE 25



SORRENTO
PAGE 23



HUMECRAFT
PAGE 22



CHIC RANGE
PAGE 26



STRATA RANGE
PAGE 26



PREMIUM RANGE
PAGE 27



**MIRROR
SQUARE TOP**



**MIRROR
ARCH TOP**



**MIRROR
FULL**

SMARTROBE INSTALLATION



Scan QR code to view our installation video





CAVITY UNIT



ASPIRE AND EVOLUTION
Super smooth ball bearing assembly and carrier featuring nylon lock tab for easy door removal and reinstallation without additional adjustments required.



U TRACK DOOR STOP
For double cavity application



ASPIRE

PREMIUM METAL CAVITY UNIT

- Top of the range with galvanised steel back posts slats and track - termite proof
- Smooth 4 wheel ball bearing carriages
- Jump free U track - smooth operation
- Maximum door mass 70kg
- Quick release mechanism to easily remove door for painting or modification



EVOLUTION

TIMBER DELUXE CAVITY UNIT

- Available in plain or treated timber
- Same architrave height as a hinged door
- Smooth 4 wheel ball bearing carriages
- Jump free U track - smooth operation
- Maximum door mass 70kg
- Quick release mechanism to easily remove door for painting or modification

Cavity Units are recommended for 35mm doors

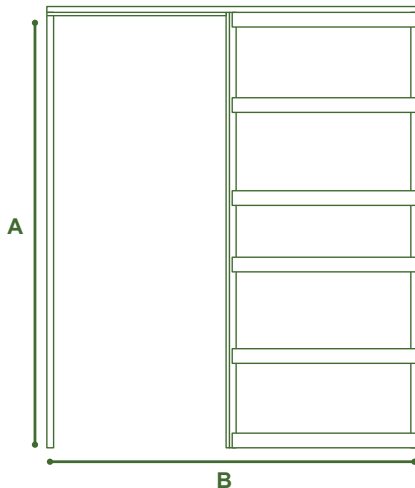

OPENING SIZES

Unit size is tight, please allow extra for packing when preparing the opening.

A - Height = Door height + 70mm (QLD. VIC. SA. TAS. WA)

A - Height = Door height + 80mm (NSW. ACT)

B - Opening width for Flush pull = 2 x Door + 10mm (Flush pull the door protrudes 50mm)

B - Opening width for Flush jamb = 2 x Door + 60mm (Flush jamb the door is flush with split jamb)

CAVITY UNIT INSTALLATION



Scan QR code to view our installation video





GLAZING OPTIONS

		FROSTED					CONTEMPORARY			
<p>Square (■) denotes the glass available for this door or sidelight.</p> <p>N.B. Clear glass available for ALL doors and sidelites.</p> <p>Availability varies for each state.</p>										
		Frosted Black Orchid	Frosted Rose Bud	Frosted Kookaburra Jewel	Kookaburra Green Leaves (Cathedral)	Wysteria (Cathedral)	Africana	Rice Paper	Translucent or Frost	
ENTRANCE	Savoy1200	XS24, XS26, XS28, XS45					■	■	■	
	Verve	VER1, VER2, VER4, VER6, VER8, VER11						■	■	
	Linear 100 Series	XLR110, XLR120, XLR160, XLR180								
	Illusion	XIL1, XIL2, XIL3, XIL6, JST11						■		■
		XIL21, XIL22, XIL23, XIL26, JST11						■		■
	Newington	XN6, XN12						■		■
		XN1, XN2, XN9, XN5, XN11, XN13, XN14, XN16						■	■	■
		XN7						■	■	■
	Nexus	NEX30, NEX40						■	■	■
		NEX35						■	■	■
	Savoy	XS3, XS4	■	■	■	■	■	■	■	■
		XS11						■	■	■
		XS24, XS26, XS28, XS45						■	■	■
	Joinery	JST1, JST2, JST11, JST12, JST4, JST5, JST6, JST10						■	■	■
	Regency	XR1, XR2		■	■	■				■
		XR5, XR6		■	■	■				■
	Vaucluse Premier	XVP5, XVP6		■	■	■				
XVP12, XVP13, XVP14		■	■	■	■	■	■	■	■	
Grange	XGE4, XGE5, XGE8						■	■	■	
Carringbush	XCB1, XCB2, XCB5					■				
Sandgate	SG8, SG9, SG10	■	■	■	■	■			■	
Glass Opening	XF1, XF3, XF8						■	■	■	
INTERNAL	Joinery/ Lincoln	LIN1, LIN10					■	■	■	
		SAV3	■	■	■	■			■	
	Humecraft	HMCS, BF30	■	■	■	■	■	■	■	
		HMC11						■	■	■
	Moulded Panel	OAK-G, BF19, ASC-G, BF28	■	■	■	■			■	
Linear 200 Series	HLR210, HLR220, HLR260, HLR280									

Glass colours are as accurate as modern photographic and printing processes allow.

Glass images are not to scale.

Factory glazed doors comply with glazing standards AS 1288-2006



GLAZING OPTIONS

CONTEMPORARY				TRIPLE GLAZE LEADLITE							BUDGET LEADLITE			LINEAR	
Cathedral	Panama	Slumped	Geostep	Triple Glaze Bevelled Jewel	Triple Glaze Bevelled Flower	Triple Glaze Classique	Triple Glaze Bevelled Flower	Triple Glaze Tear Drop	Triple Glaze Argyle	Triple Glaze Crystal Blue	Budget 3 Diamond Bevel	Budget Bevel Flower	Budget Diamond Cluster	Linear Clear	Linear Satinlite
■			■												
■			■												
														■	■
■		■													
■		■	■												
■		■	■												
■		■	■												
■	■										■	■	■		
■		■	■												
■			■												
						■	■								
						■	■	■							
■	■			■		■	■	■	■	■	■	■	■		
■															
■	■								■	■					
■	■		■								■	■	■		
■	■														
■	■														
■	■														
■	■														
														■	■



COMMERCIAL PRODUCTS

STEEL DOOR FRAMES

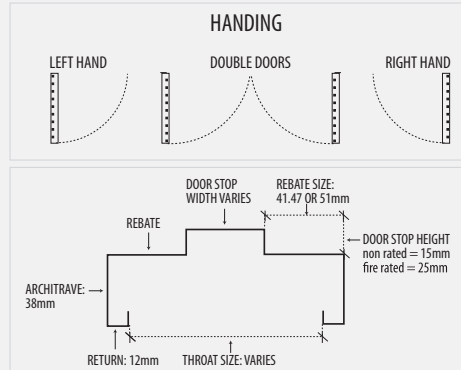
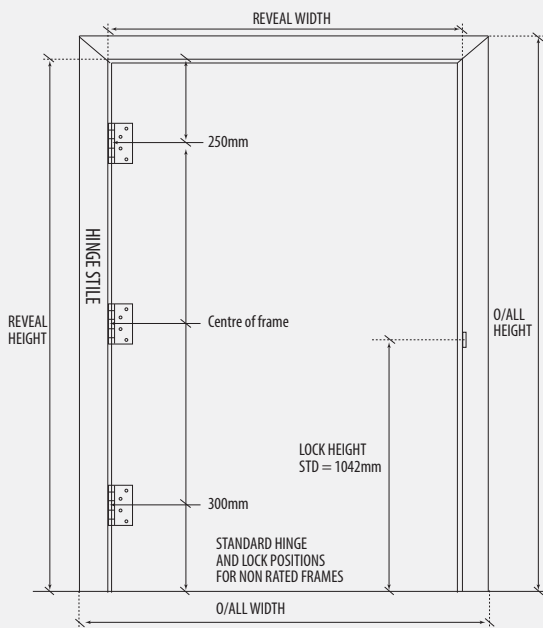

- 3 Hinges (required to meet door manufacturer's guarantee for solid doors)
 - Hinges screw fixed to frame to allow removal if required for easy door hanging
 - Simple installation
 - Ready for priming or painting
 - Zinc finish
- All components supplied for brick/block and partition walls
Left or right hand available

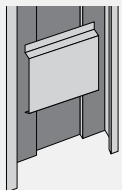

STRAP FIX

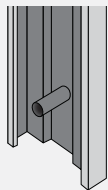

TUBE FIX

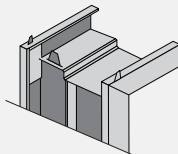

CORNER DETAIL

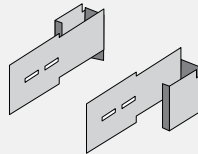

STUD CLIPS

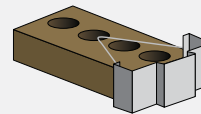

JAMB BRICK

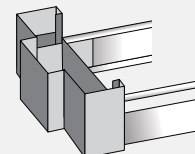

JAMB STEEL

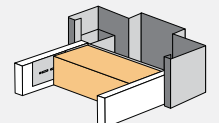

JAMB GYROCK

OVERSIZE DOORS



At Hume Doors & Timber we manufacture doors for a multitude of applications and your State office will gladly accept your enquiry no matter how large or small. As a guide, we provide the following:



- AIR GRILLS**
- Aluminium
 - Snap in



ALUMINIUM T-BARS



- METAL CLAD DOORS**
- Zinc
 - Colorbond

FIRE DOORS

1HR, 2HR, 3HR, 4HR



- Incorporate TVC Core
- Full metal inner plates for hinge locations, closer and lock
- Choice of face materials: MDF, ply, tempered hardboard



- GLAZED PANELS**
- Suit Firedoors
 - Panel Sizes: 600x100, 300x200 or 450x120





TIMBER MOULDINGS PROFILES

ALL SIZES ARE IN MILLIMETRES. CHECK YOUR STATE FOR AVAILABILITY. FIBRE CEMENT PRODUCTS ARE ALSO AVAILABLE

● SILK TRIM - Medium density fibreboard (HMR)

● PINE TRIM - Finger Jointed Pine

● MERANTI - Stain grade

 Dar Square Dressed	 Loose Stop Jamb Set (92/112 x 18)	 Single Flat Bevel (67 x 18)	 Single Bevel (42/67/92 x 11, 42/67/92 x 18)	 Pencil Round (42/67 x 11, 42/67/92 x 18 Bullnose skirt WA only)	 Double Pencil Round (67 x 18 Bullnose arch WA only)	 Olympic (67/92 x 18)	 Single Housing Trust (42/67/92 x 18)	 Bullnose (42/67/92 x 11, 67/92 x 18)				
 Half Splayed (42/67/92 x 11, 42/67/92/140 x 18)	 Splayed Pencil Round (67/92 x 18)	 Old Classic (42/66 x 11)	 Replica (67 x 18)	 Replica (85 x 18)	 Replica (135/188 x 18)	 NSW Classic (75/95/135 x 18)	 Victorian Colonial (42/67/92/140 x 18)	 Old Colonial (42/66/92 x 11)				
 Old Colonial No.2 (42/66 x 11)	 WA Colonial (67/87 x 18)	 WA Colonial (140/190 x 18)	 NSW Colonial (42/67/92/140 x 18)	 Australian Colonial (42/67 x 12)	 Berkley (67/92 x 18)	 Lamb's Tongue (67/92/140/190 x 18)	 Colonial (Vic) (66/90 x 18)					
 WA Federation (67/80/125 x 18)	 Traditional Profile (67/92 x 18)	 Traditional Victorian (67/92/140 x 18)	 Traditional Profile (140 x 18)	 Old Step Profile (42/66 x 11)	 NSW Step Profile (67/92/140 x 18)	 Coolum Cove (42/66 x 11)	 Fly Mould / D Mould					
 Cornice (42/66 x 15)	 Scotia (31 x 31)	 Quad (11 x 11, 18 x 18)	 Glazing Bead (18 x 12)	 Storm Mould (30 x 18)	 Cover Batten	 Full Splay (41/66 x 18 SPECIAL)	 Chamfer (128/146/178 x 18)					
 Capping (170mm x 25)	 SA Collection (32 x 8)	 NSW Collection (30 x 14)	 NSW Chair Rail (92 x 18)	 Nosing	 Angle (31 x 31)	 Angle (31 x 31)						
HANDRAILS	 Ladies Waist (65 x 65)	 Bread Loaf (65 x 65)	BOTTOM RAILS	 Bottom Rail (66 x 31)	 Bottom Rail (66 x 42)	FASCIA	 Fascia (180 x 25/30, 230 x 31)	BALUSTERS	 Baluster (42/62 x 18, 42 x 42)	MID RAILS	 Mid Rail (66 x 42mm)	 Reb Mid Rail (66 x 42)



STEEL DOOR FRAME WARRANTY

Subject to terms and conditions set forth herein, steel door frames manufactured and/or supplied by: Hume Doors & Timber (Aust) Pty. Ltd., Hume Doors & Timber (Qld) Pty. Ltd., Hume Doors & Timber (Vic) Pty. Ltd., Hume Doors & Timber (SA) Pty. Ltd. or Hume Doors & Timber (WA) Pty. Ltd. (hereinafter referred to as "the Company") are warranted by the manufacturer and/or supplier for one year from the date of shipment by the manufacturer and/or supplier to be of good material and workmanship, free from defects which render them unserviceable or unfit for the use for which they were manufactured.

THE COMPANY WARRANTS:

1. Goods manufactured and/or supplied for a period of one (1) year as from the date of shipment, to be free from defects in material and workmanship which would render them unserviceable or unfit for normal use.
2. To the extent permitted by law or the express provision of any statute or otherwise hereby expressly excluded and in respect warranties that cannot be so excluded, these terms and conditions shall be read such that those statutory warranties are read as being in addition to the warranties hereby given.
3. Subject to Clause 2, the warranty in Clause 1 shall be read subject to the following matters being excluded as defects:

- 3.1 Frames not accorded reasonable treatment by the customer.
- 3.2 Damage or defects arising out of, or in connection with, shipment or storage after frames leave the control of the company (i.e. delivered to site or handed over to a carrier). Frames must be inspected by the customer for visible defects immediately upon delivery.
- 3.3 Claims for non conforming deliveries (incomplete defective or incorrectly supplied) will only be considered if made within 3 working days of receipt or delivery of frames. All delivery checks are the responsibility of the customer.
- 3.4 Under NO circumstance will the company be liable if frames are installed before checking that they are supplied correctly and are free from defects.
- 3.5 Factory priming is only to protect frames in transport and general handling it is the responsibility of the customer to immediately on delivery of all frames apply 2 coats of compatible sealing priming to ensure corrosion or the like does not occur.
- 3.6 It is the responsibility of the installer to ensure that the frames are installed plumb, square and suitably anchored using the correct fixing points.
- 3.7 Storage and security of the frames is not the responsibility of the company.
- 3.8 Stainless steel hinges are required to be maintained every 2 months to ensure prevention of tarnishing and corrosion.



GUARANTEE DOORS

Subject to terms and conditions set forth herein, doors manufactured by: Hume Doors & Timber (Aust) Pty. Ltd., Hume Doors & Timber (Qld) Pty. Ltd., Hume Doors & Timber (Vic) Pty. Ltd., Hume Doors & Timber (SA) Pty. Ltd. or Hume Doors & Timber (WA) Pty. Ltd. (hereinafter referred to as "the Company") are guaranteed by the manufacturer for five years from the date of shipment by the manufacturer to be of good material and workmanship, free from defects which render them unserviceable or unfit for the use for which they were manufactured.

TERMS AND CONDITIONS

Natural variations in the colour, texture or grain pattern of the wood or MDF are not to be considered defects. Doors must be accorded reasonable treatment by the purchaser and should be stored or hung in dry buildings and not in damp, moist or freshly plastered areas. The utility or structural strength must not be impaired in the fitting of the door, the application of hardware, or cutting and altering of the door for lights, louvres, panels or any special details. A maximum of 3mm may be trimmed from any edge of the door. This must be done evenly. Normal "show-through" of frame components in doors shall not be considered a defect. Entrance/solid doors up to 2040 x 820 require three hinges, larger doors require four hinges or pivot system. **ENTRANCE DOORS SHOULD BE HUNG IN WEATHER PROTECTED AREAS.**

Doors and door systems including pivot systems that are installed in a fully exposed situation including opening out doors will not be warranted unless there is adequate overhead protection.

Immediately after fitting, and prior to hanging, the entire door, including the top and bottom edges, must receive two coats of undercoat and two coats of paint. This includes doors that are supplied raw or factory primed. If staining, exterior grade varnish or sealer must be used and its application to be equivalent to paint finish, to prevent absorption of moisture. Semi gloss or satin finishes are recommended for all doors to reduce "show-through". Exterior finishes to be applied strictly in accordance with paint manufacturers instructions. Entrance and exterior doors should

be finished in light reflective colours to reduce the risk of heat absorption which may cause warping. **DARK COLOURS MAY VOID WARRANTY.** Regular maintenance should be provided to prevent deterioration. Where any legislation provides for remedies for the Company's breach of a condition or warranty whether statutory or otherwise, then, at the Company's option, the customer's sole remedy for such breach except a breach of Section 69 of the Trade Practices Act will be limited to: such remedy, or the repair of the products, or the replacement of the products or the re-supply of the products; or the payment of the cost of replacing the products; or the cost of having the services supplied again; or the re-provision of the services. No claim will be accepted unless notified in writing to the Company within seven (7) days of the date of delivery of the products or the supply of the services.

The Company will not be held responsible for additional charges of hanging, painting or other charges arising from the replacement of doors. Any such defects must be brought to the attention of the manufacturer when discovered and in any event within five years from the date of shipment by the Company. The Company is not liable to reimburse any purchaser for doors repaired or replaced without the prior written consent of the Company to such repair or replacement. The Company will not assume responsibility for doors which become defective because of failure to follow these conditions or hazards of shipment or storage, after doors leave the control of the Company. The Company will not be liable for any costs, claims, damages or demands arising from the personal injury, loss or damage whatsoever occurring to the customer or its agents, servants as a result of either acts or omissions of the customer. The Company will not be liable for any consequential loss or damage, whether due to its negligence or otherwise. The Company will not be liable to the customer for the Company's failure to comply with its obligations to the customer due to any cause beyond the Company's reasonable control and the Company's obligations affected by such cause are suspended while the cause continues to prevent or hinder the Company's performance.

ADVISORY NOTE

Considerable damage can occur during the delivery of doors particularly to country areas. "Special Packaging" is recommended (optional extra cost) in an attempt to prevent transit damage. The Company is not responsible for any transit damage.

INTERPRETATION OF WARP

Warp shall be interpreted as meaning the cupping/bowing or twisting of doors. It refers to distortion within the door itself and not its relationship to the jambs or frame in which it is hung. Warp exceeding 5mm for doors up to 2100 x 920mm, 6mm for doors over 2100 x 920mm and up to 2340 x 920mm and 8mm for doors up to 2340 x 1200mm shall be considered a defect. Doors in excess of 2340mm high or 1200mm wide are not guaranteed against warp.

EXCLUSIONS

The guarantee against warp does not apply to the following:

- a. Doors with face veneers of different species.
- b. Doors that are improperly hung or do not swing freely.
- c. External flush doors which have been painted or stained dark colours, or different colours each face.

Experience has demonstrated that when warp occurs after doors have been delivered to storage or building sites, it is usually due to improper storage or adverse moisture conditions after hanging and not to faulty manufacture. The Company will accept no responsibility for doors when moisture content of the timber falls below 12% or exceeds 18%. The Company will not accept responsibility for conditions wholly beyond its control. However, the Company should be consulted promptly if excessive warping occurs to provide assistance in overcoming the difficulty.



OVERHEAD PROTECTION

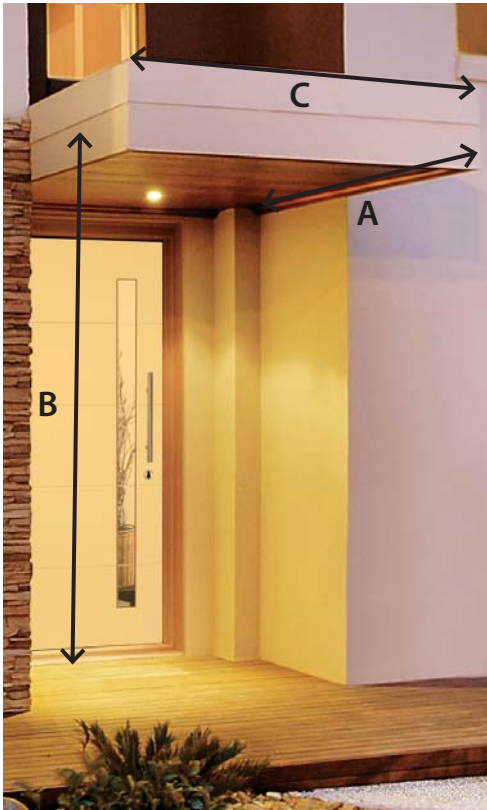

With Australia's climate extremes exterior/entrance doors will weather differently and timber doors are more susceptible to the elements than steel, aluminium or fibreglass doors.

Depending on your location and aspect the required overhead protection will vary, with tropical areas generally requiring more overhang than southern states. The chart below will assist in determining the size of overhead protection which will vary depending on home design and adjacent walls.

Dimension 'C' – subject to adjacent walls – minimum width same width as entry frame
Note: colour choice for your exterior door will also affect weathering. Dark colours absorb heat, accelerating door deterioration, warping and bowing. For door guarantee refer page 52.

CLIMATE	DOOR DIRECTION			
	North	South	East	West
Coastal	$A = 1/2 B$	$A = B$	$A = 1/2 B$	$A = B$
Tropical	$A = B$	$A = B$	$A = B$	$A = B$
Arid	$A = B$	$A = 1/2 B$	$A = B$	$A = 1/2 B$
Mild	$A = 1/2 B$	$A = 1/2 B$	$A = 1/2 B$	$A = B$



CARE & MAINTENANCE

1. After selecting and purchasing your Hume door, store flat in a dry, well ventilated area prior to installation.
2. Your timber door may be affected by changes in temperature, moisture and location.
3. Before fitting the door, all six door surfaces should be sealed initially then after installation painted, stained or clear finished with good quality products. Follow the paint manufacturer's instructions with the correct number of coats on ALL surfaces.
4. Light reflective colours are recommended for Entrance Doors to reduce the possibility of bow, twist or warp. Dark colours may void Hume guarantee. Semi gloss finishes are recommended. Paint with a light reflectance value (LRV) finish greater than 50 should be used on External Doors. White – LRV approx, 95 Black – LRV approx 5.
5. Use the same colour on all six door surfaces. Different colours may cause doors to warp.
6. Entrance Doors require overhead protection (above).
7. Location and fitting of your door furniture depends on door construction. Honeycomb core doors have a lock block (piece of timber) located generally on the side with the Hume label and door furniture should be fitted in this location. Solid doors may have door furniture installed at any selected height, either side of door.
8. Door maintenance is necessary for long term performance and periodic inspections are recommended. At the first signs of deterioration, your door should be properly refinished, making sure that all bottom surfaces of the door receive proper resealing and painting.
9. To clean your door, use a damp cloth. Do not hose or use chemicals or abrasives on your door. Lightly oil hinges and door furniture for optimum performance.



5 YEAR GUARANTEE 

Contact your nearest Hume Doors stockist or the Hume Doors website for more information.



CONTACT DETAILS

www.humedoors.com.au



NEW SOUTH WALES

HUME DOORS & TIMBER – (AUST) PTY LTD
ABN 39 001 472 493

Sydney Office & Showroom

120 Hume Highway, Lansvale NSW 2166
PO Box 333, Cabramatta NSW 2166
P | 02 9794 1111 F | 02 9794 1199
E | info@humedoors.com.au

Port Macquarie Branch

No. 2 Belah Road, Port Macquarie NSW 2444
P | 02 6581 0011 F | 02 6581 0091 E | hdtpm@humedoors.com.au

Newcastle Branch

7 Waterloo Avenue, Thornton NSW 2322
P | 02 4966 8880 F | 02 4966 8881 E | hdtnc@humedoors.com.au



QUEENSLAND

HUME DOORS & TIMBER (QLD) PTY LTD
ABN 25 009 994 996

86 – 92 Mudgee Street, Kingston QLD 4114
PO Box 2243, Logan City D.C. Qld 4114
P | 07 3489 6200 F | 07 3489 6299 E | sales@humedoorsqld.com.au

Sunshine Coast Branch

14 Junction Drive, Coolool Beach Qld 4573
P | 07 5446 2640 F | 07 5446 3530 E | hdtcoolool@humedoorsqld.com.au

Cairns Branch

64 Fearnley Street, Portsmith, QLD 40870
P | 07 4041 2099 F | 07 4041 2047 E | hdtcairns@humedoorsqld.com.au

Northern Territory Branch

3 Adams Road (Cnr Beresford), Yarrowonga NT 0830
P | 08 8932 3733 F | 08 8932 3799 E | hdtnt@humedoorsqld.com.au



VICTORIA

HUME DOORS & TIMBER (VIC) PTY LTD
ABN 87 006 329 906

33 Remington Drive, South Dandenong VIC 3175
PO Box 4236, South Dandenong VIC 3164
P | 03 9799 6888 F | 03 9799 9688
E | hdtvic@humedoors.com.au, timbersalesrep@humedoors.com.au,
doorsales.vic@humedoors.com.au, vicquotes@humedoors.com.au

Tasmania serviced by Victoria



SOUTH AUSTRALIA

HUME DOORS & TIMBER (SA) PTY LTD
ABN 34 007 512 209

89 Heaslip Road, Burton SA 5110
PO Box 2037, Salisbury Downs SA 5108
P | 08 8280 2000 F | 08 8280 8099 E | hdtsa@humedoors.com.au



WESTERN AUSTRALIA

HUME DOORS & TIMBER (WA) PTY LTD
ABN 62 009 421 569

75 Briggs Street, Carlisle WA 6101
PO Box 118, Welshpool WA 6986
P | 08 9470 1800 F | 08 9472 3802 E | hdtwa@humedoors.com.au

Doors illustrated in this catalogue are constantly being improved and we reserve the right to change prices or specifications without notice. Doors are supplied unfinished and unglazed unless otherwise specified. Doors in showrooms and some displays are factory finished. Similar results may not be achievable using normal painting applications e.g. brushes, rollers, etc.



9314557410009

100% Australian Owned